



Water Witch Automatic Water Leveller

Installation & Set Up Guide

A fully automated pool and spa water leveling System

Full Electrical Certification

Inside & outside use



(V99086)

C-Tick Approval

N1116

COOKE
INDUSTRIES

Index

Page 1: Three Main Components

Page 2: Diagrams 3, 4, 5, 6

Page 3: Installation Guide

Page 4-5: Sensor & Solenoid Connections

Page 6: Initial Set Up- testing of water witch

Page 7: Setting the sensor

Page 8: Operating Mode (Dip Switch Settings)

Page 9: Internal Block Diagram Of control

Back Page: Contact Information

Danger!

This unit is powered by a 240Volt AC supply which could cause serious injury or death.

ALWAYS SWITCH OFF AND REMOVE THE POWER LEAD FROM THE POWER SUPPLY PRIOR TO OPENING CONTROL BOX LID.

Three Main Components

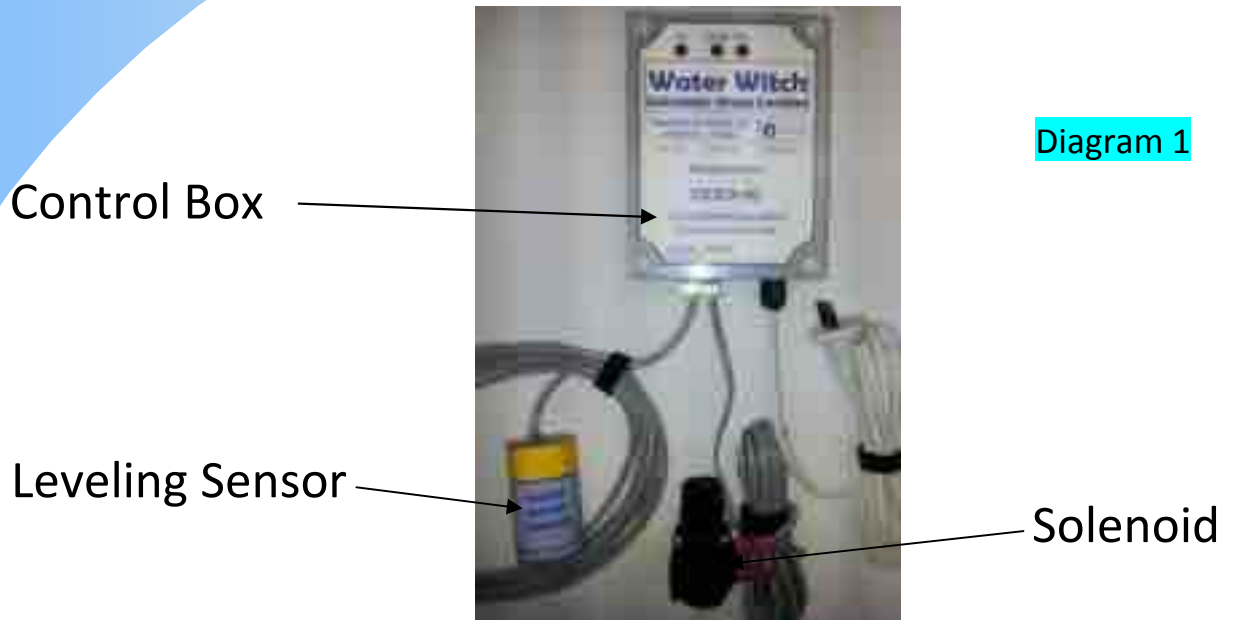

Control Box

Co-ordinates the above items with visual indicators of status shown in Diagram 2.

Solenoid

Solenoid with indicator arrow that controls the flow of water.

Leveling Sensor

Our patented leveling sensor designed to fit into 40mm and 50mm Class 9 pipe.

NOTE: The sensor will not fit into 40mm Class 12 pipe.

When light is on status is as follows:

Diagram 2

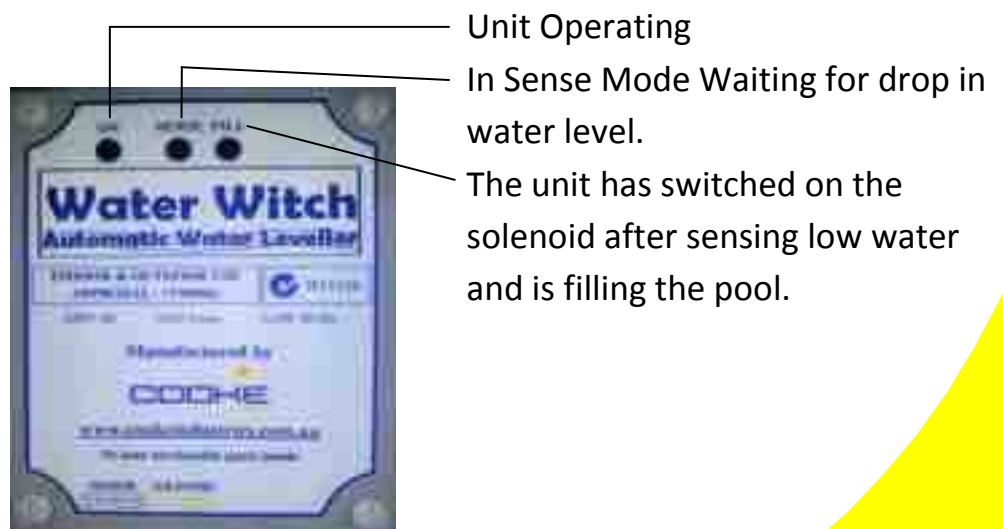

Diagrams 3, 4, 5 and 6

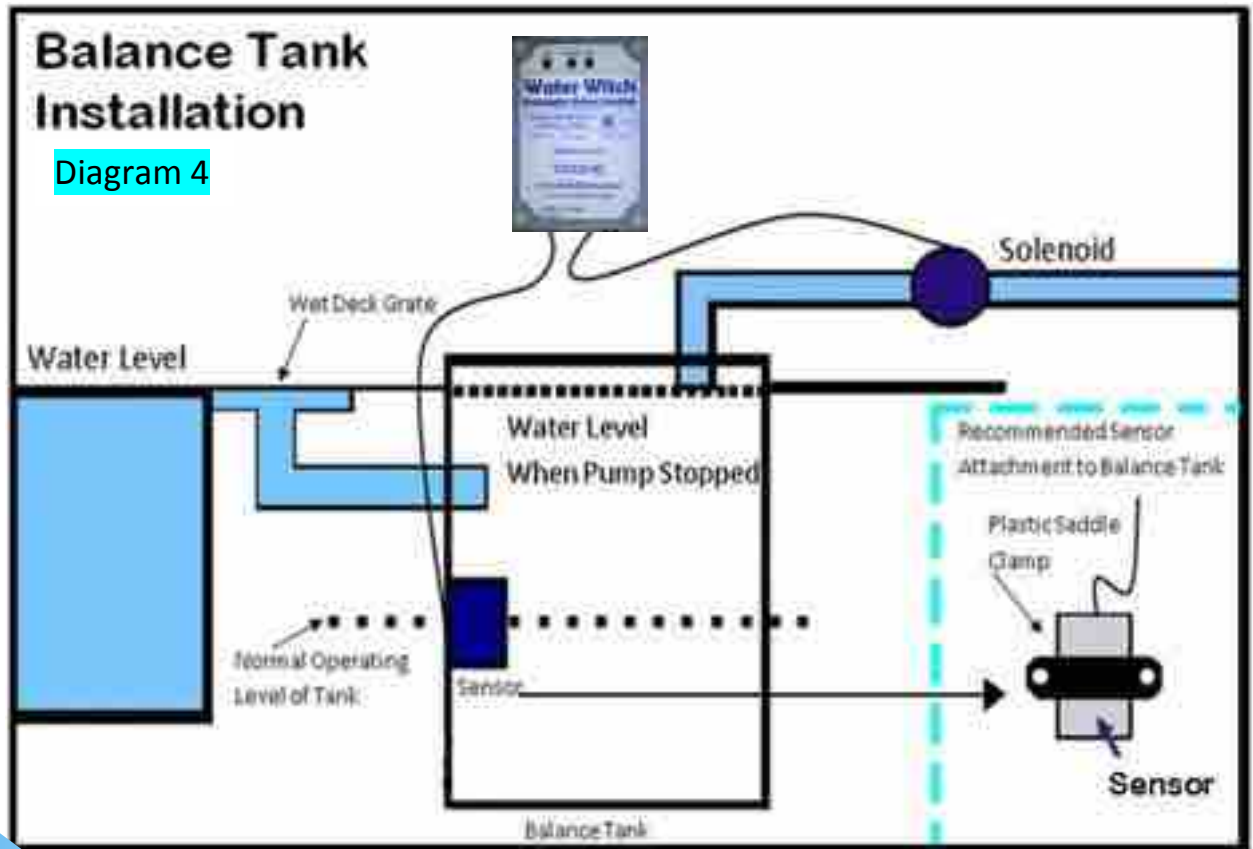
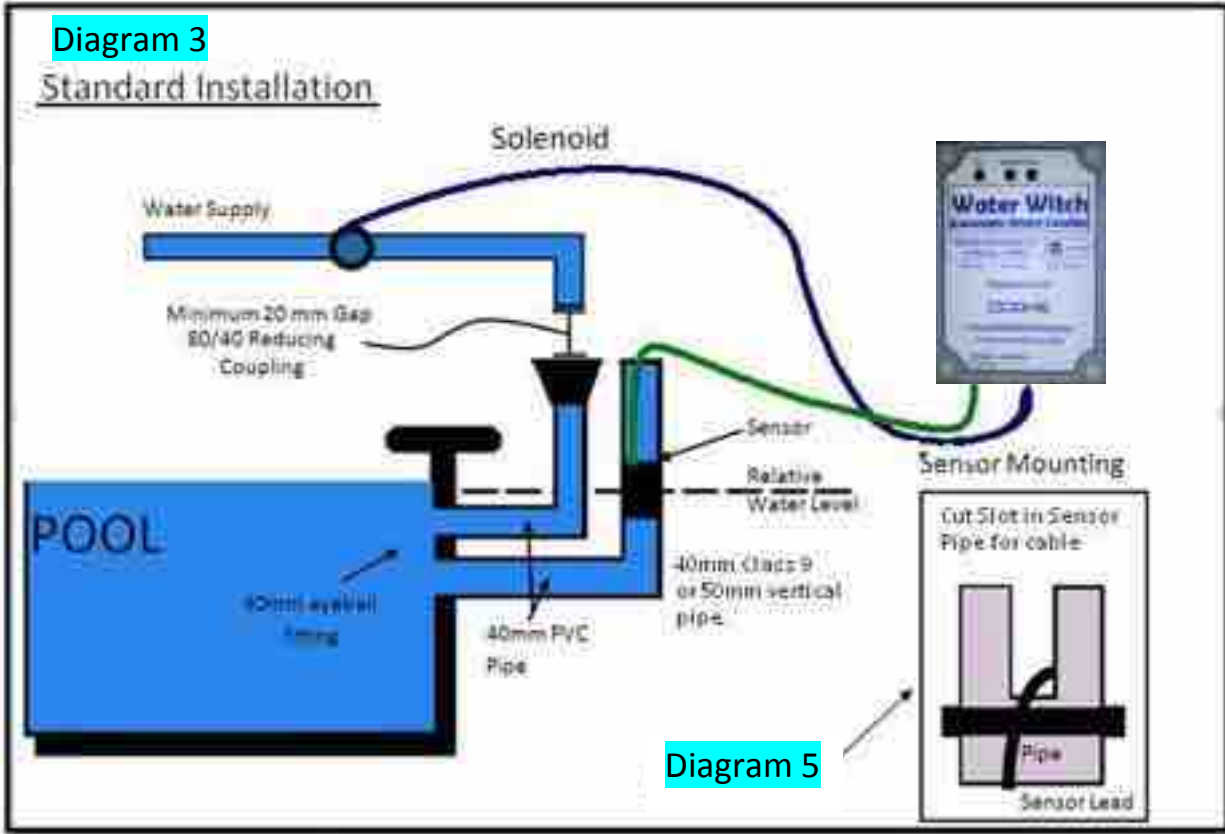

Diagram 6

Installation Guide

- Control Box** Mount the control box at least 1.2 meters off the ground using the steel bracket provided.
- Solenoid** The solenoid must be installed in the water supply line using the flow direction arrow indicated on the solenoid body.
- Sensor** Refer to the diagrams 5 & 6 on the opposite page for mounting of the sensor

POOL INSTALLERS

Sensor Pipe & Fill Plumbing

The suggested method of plumbing is two 40mm class 9PVC pipes plumbed through the pool wall and returned to the pump and filter area.

These pipes are placed approximately 300mm below normal water level and finished off in the pool with push in eyeballs to match the other pool fittings. The pipes are usually run along the suction and return trench and elbowed up near the pool equipment.

Important

These pipes must remain below the water level by a minimum of 200mm (more is better) until elbowed into the vertical position.

A minimum vertical height of 300mm above the top of the pool is required for both pipes.

4

Sensor & Solenoid Connections

Diagram7



Sensor Cable

If the standard cable length is insufficient contact your distributor as 20 & 30-meter cables are available. Custom made longer lengths can be manufactured.

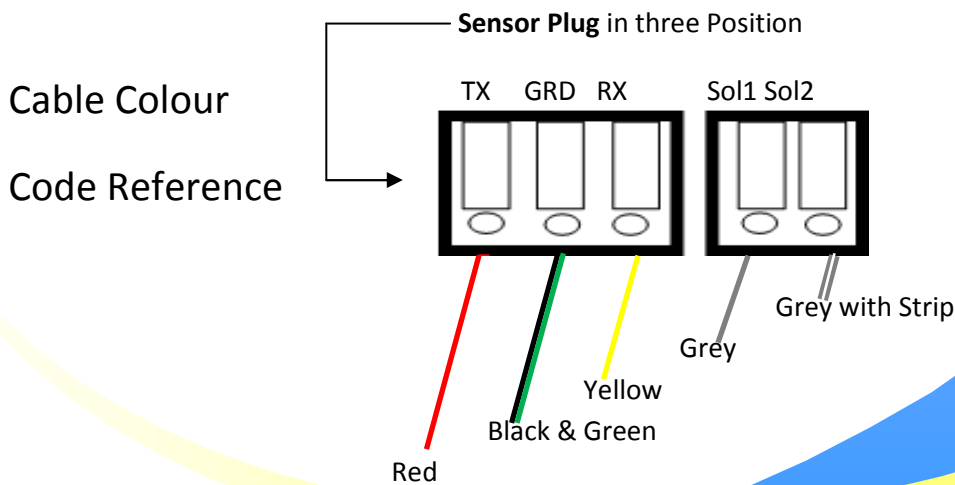

The Water Witch is designed to be installed close to the pool equipment. Both the sensor and solenoid leads are normally 5 meters long with plugs attached for connections to the base of the control box as shown in Diagram 7 (Water Witch 20 & 30 for the balance tank installs come with a 20 or 30 meter Sensor lead respectively.)

**DO NOT CUT OR JOIN
THE CABLE.
THIS WILL VOID
WARRANTY**

Initial Set Up

Step by step Guide

Once the Water Witch has been mounted properly, **TESTING OF THE WATER WITCH** is required. To ensure that the sensor and solenoid are working properly, please complete the following steps:

- Step 1:** Ensure the pool is filled to the operating water level required.
- Step 2:** Connect the sensor and solenoid plugs to the control box ensuring that the plugs are connected as indicated on the label on the control box (**sensor left**; solenoid right).
- Step 3:** Turn power and water supplies on. The ON light will automatically come on and begin to flash. Depending on what position the sensor is in, will determine if the sense light is on and flashing or the fill light is on.
- Step 4:** Holding the sensor upside down, check that the ON & SENSE lights are flashing approximately every two seconds.
- Step 5:** Turn the sensor the right way up and the ON light will continue to flash and the FILL light will come on. This will turn the water on to fill the pool.

IF THE WATER DOES COME ON, YOU HAVE CORRECTLY INSTALLED THE WATER WITCH SYSTEM.

PLEASE FOLLOW STEPS 6 TO 9 TO **SET THE SENSOR.**

SETTING THE SENSOR

Remember, your pool water level must be correct to continue:

Step 6: Very slowly lower the sensor into the PVC sensor pipe until the water flow stops and the ON & SENSE lights flash every two seconds.

Step 7: Once the water turns off, the SENSOR is now at the correct required position in the pipe. Fasten the sensor lead to the pipe with a zip tie to prevent the sensor from moving up or down in the pipe.

Step 8 As an indicator for the position of the sensor in the pipe, mark the sensor lead with a pen/marker to indicate how far the sensor has been lowered into the pipe.

Step 9 If the pipe is in an area where debris can get into the pipe, it is recommended to put an end cap on the pipe but make sure it is not air tight.

THE SENSOR IS NOW SET AT THE CORRECT LEVEL AND IS TO REMAIN AT THIS LEVEL TO ENSURE THAT THE YOUR POOL IS ALWAYS FILLED PROPERLY.

IMPORTANT INSTALLATION STEPS:

PLEASE FOLLOW STEPS 10 – 12 TO ADJUST THE WATER WITCH FROM TEST MODE TO OPERATING MODE.

Adjustment from Test Mode to

OPERATING MODE

(DIP SWITCH SETTINGS)

- Step 10** Switch the power off and unplug the power cable.
- Step 11** Remove control box cover and set Dip Switches to the correct mode as indicated in the **Table One** below.
- Step 12** Put the cover back on, plug in the power lead and switch on the power.

The Water Witch is now set to the correct water level and mode settings.

TABLE ONE: Dip Switch Positions relevant to pool size

Mode Description	Capacity In LTRS	SWITCH 1	SWITCH 2	SWITCH 3	SWITCH 4	TIME DELAY BEFORE AUTOMATICALLY SWITCHING WATER OFF
Test mode	NA	UP	UP	UP	UP	2 Seconds
Spa mode	Up to 10,000	UP	DOWN	UP	UP	13 Seconds
Medium mode	10,000 to 50,000	UP	UP	DOWN	UP	75 Seconds
Large/Balance mode	Over 50,000	UP	UP	UP	DOWN	330 Seconds

Internal block Diagram Of Control Box

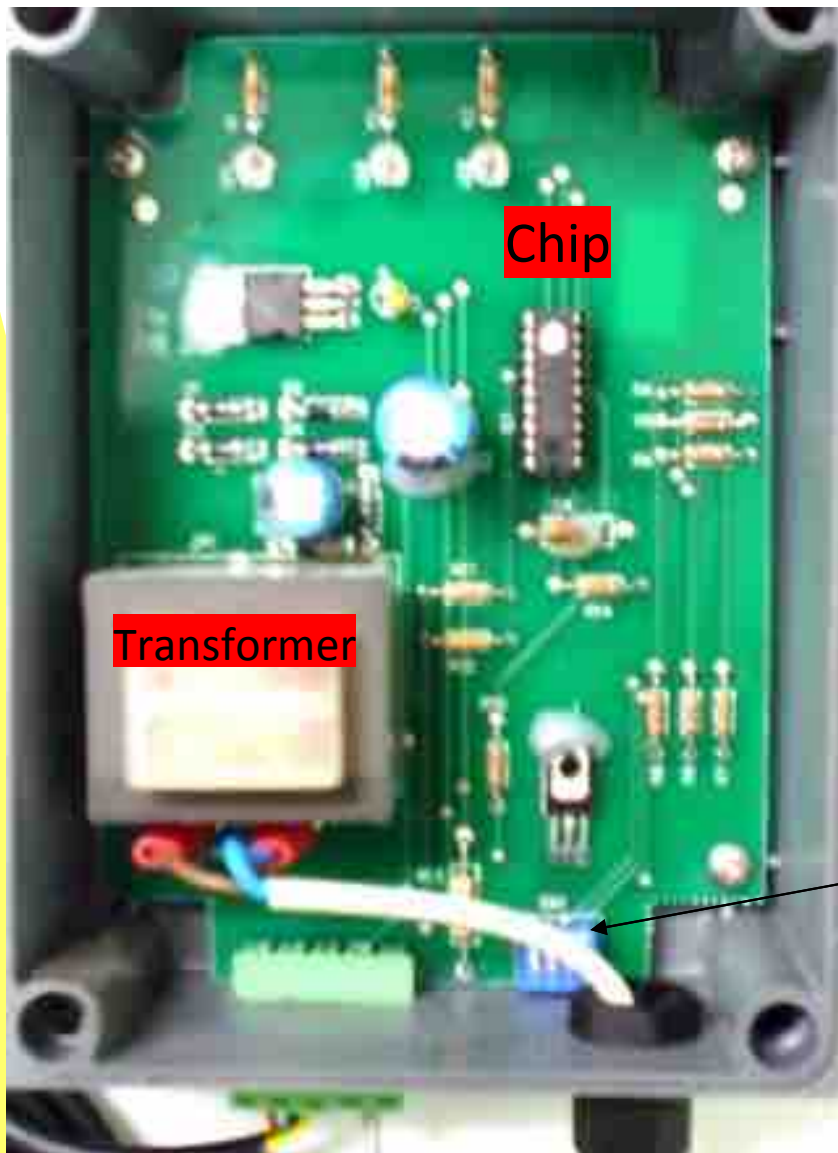

Dip switch

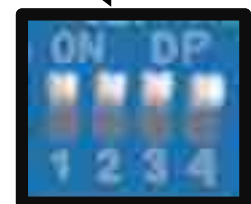

If at this stage you have any questions or you have come across a problem please call us on 1300 652 076

or 03 5023 3722

or you can refer to our web-site for trouble shooting and technical help.

www.cookeindustries.com.au

Thank you for purchasing

Water Witch
Automatic Water Leveller

The logo for Cooke Industries features a stylized orange sun icon above the word "COOKE" in a large, blue, blocky font. Below "COOKE" is the word "INDUSTRIES" in a smaller, blue, sans-serif font.

COOKE
INDUSTRIES