

POOL LIGHTING CONTROLLER

RM-WF

INSTALLATION & OWNER'S MANUAL

CONTENTS

BEFORE YOU START	3
PRODUCT SUPPORT AND INFORMATION	3
WHAT'S INCLUDED	4
MOUNTING THE CONTROLLER	5
CONNECTING TO TRANSFORMERS	6
WIRING GUIDE	7
APP INSTALLATION	8
APP SETUP	8
ADD A DEVICE	9
MULTI PLUS SETUP	13
OPERATING INSTRUCTIONS	15
TURNING LIGHTS ON	15
CHANGING SOLID COLOURS	15
COLOUR SHOWS	16
SCHEDULING	17
ZONES	19
ACCESSORY DEVICES	20
TECHNICAL SPECIFICATION	21
APPENDIX	21
TROUBLESHOOTING	21

BEFORE YOU START

The iRIS lighting system is designed to be used with the Spa Electrics MULTI PLUS model lights. (Please check product labelling to ensure it is suitable)

For Retro-fit installations, where existing transformers have been hard-wired; a suitably qualified electrician must disconnect the transformers and terminate with a plug top connection. OR the transformers are to be replaced with the Spa Electrics LV25-12 or LV50-12 models.

IMPORTANT NOTE



The diagrams and smart device images throughout this document are for illustrative purposes only, and may differ depending on your specific device and operating system (Android or Apple iOS).

WARNING



If the installation requires running wire through building structure, special wiring methods are needed.

Do not submerge.

Do not exceed the maximum ratings of individual components, wiring devices and current carrying capacity of conductors.

PRODUCT SUPPORT AND INFORMATION

Telephone: 03 9793 2299 (Business hours 8:30 – 4:30)

SALES ENQUIRIES

E. sales@spaelectrics.com.au

TECHNICAL SUPPORT

E. tech@spaelectrics.com.au

www.spaelectrics.com.au

WHAT'S INCLUDED



**iRIS Wi-Fi
Lighting Controller**

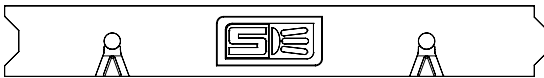

Mounting Bracket

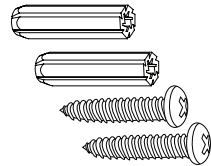

Mounting Screw Kit

MOUNTING THE CONTROLLER

Ensure that the unit is installed at least 3.5 Metres away from the pool and/or spa.

Fasten the transformer bracket to the wall ensuring the base of the iRIS Controller is at least 500mm above ground level.

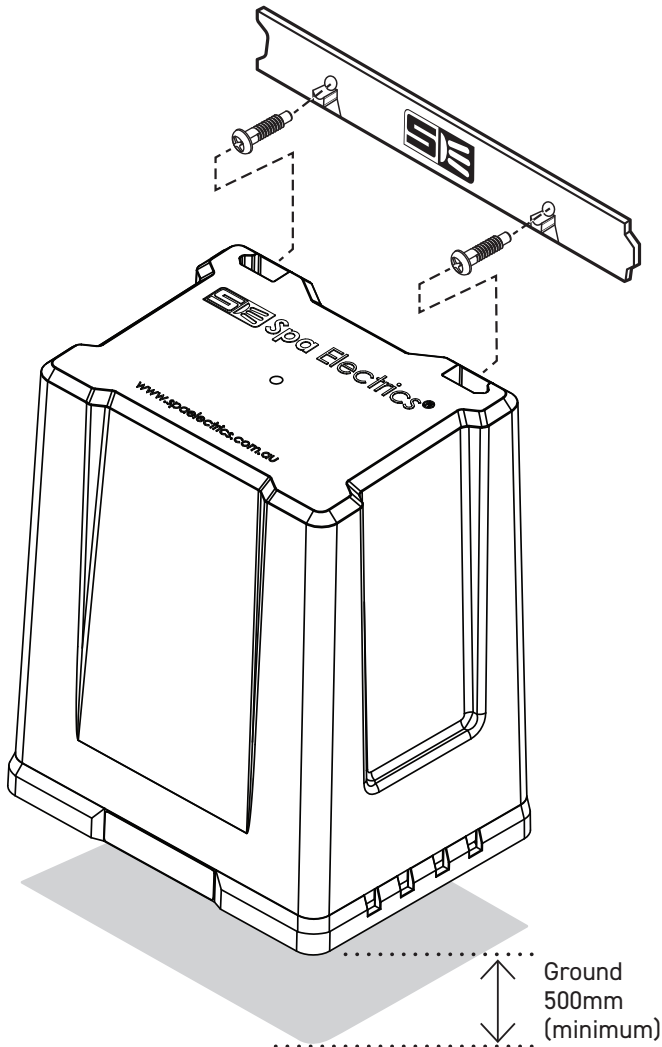

CONNECTING TO TRANSFORMERS

Plug the iRIS Controller into mains power supply.

Plug a pool light transformer into outlet indicated POOL LIGHTS as per below diagram.

Plug a spa light transformer into outlet indicated SPA LIGHTS as per below diagram.

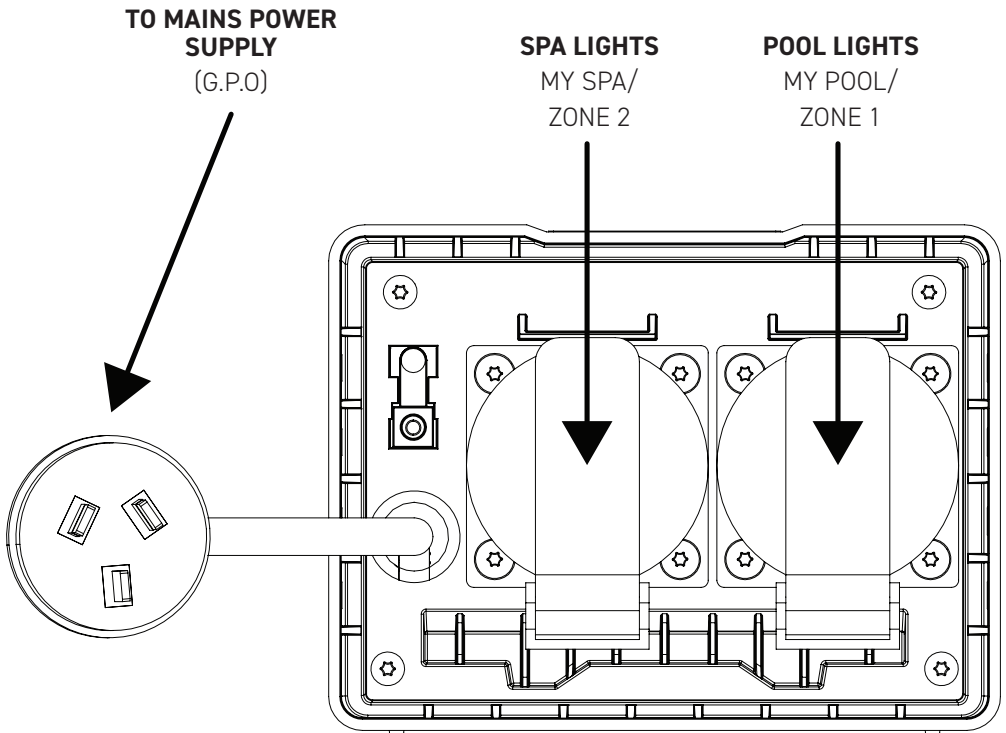

WIRING GUIDE

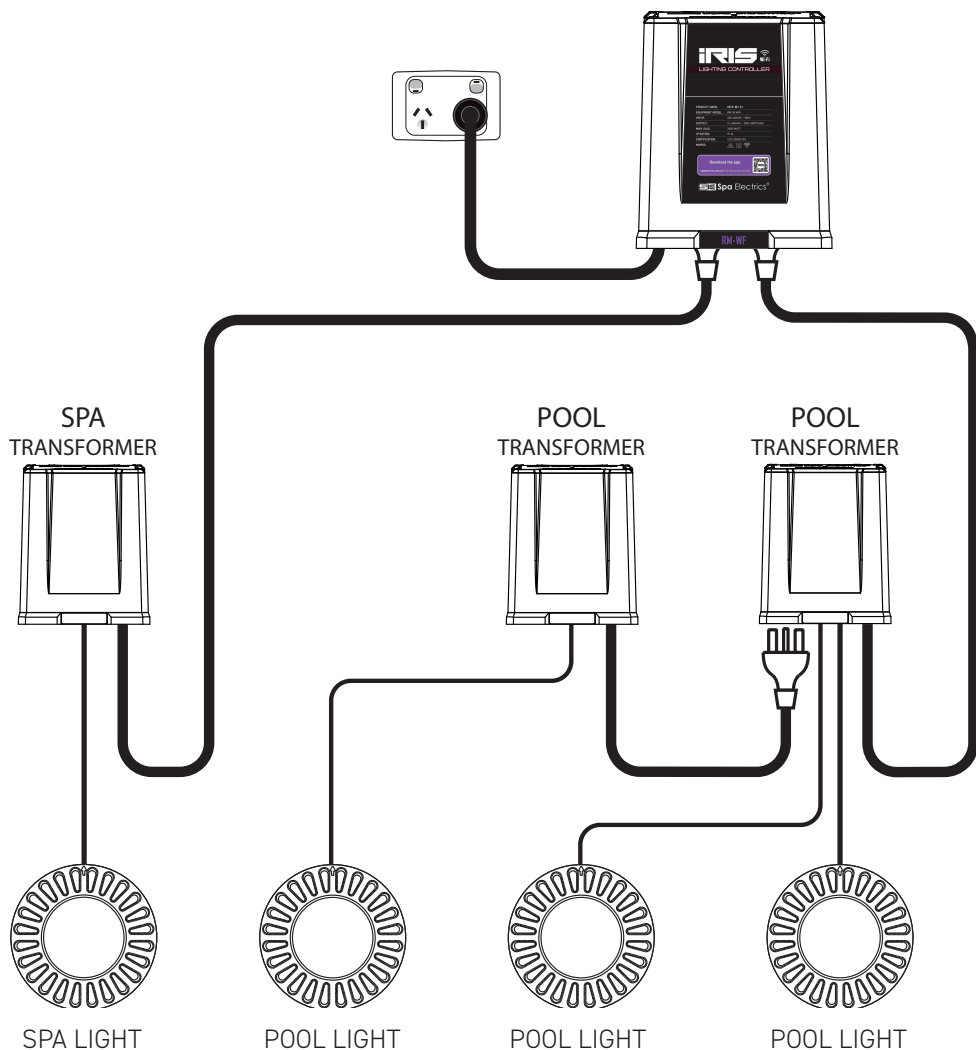

APP INSTALLATION

1. Go to your smart devices app store; Google Play (Android) or App Store (Apple iOS).
2. Search for "Smart Life - Smart Living".
3. Select to install the Smart Life app.



APP SETUP

1. Open the Smart Life app.
2. Read the terms and conditions and then tap "Agree" to proceed.
3. You may be notified to allow notifications from the Smart Life app. Follow the prompts of your specific device to either allow or don't allow according to your preference.
4. Tap "Sign Up" to create a new smart life account. Or tap "Log In" if you want to use an existing account. Or optionally you can tap "Try as Guest" to use the app without creating an account. (see Appendix 1). Proceed with your choice by following the on screen prompts.

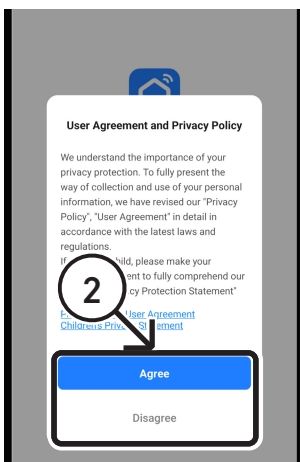

ADD A DEVICE

1. Tap the plus **+** button in the top right corner.
2. Tap "Add Device".
3. You may be prompted that the Smart Life app requires access permissions to Bluetooth and Location. Tap "Continue".

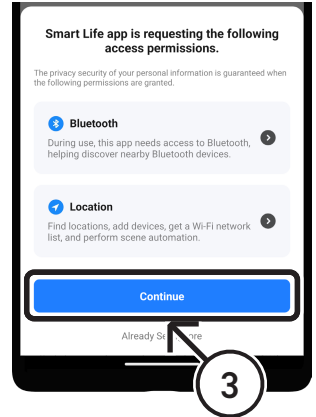
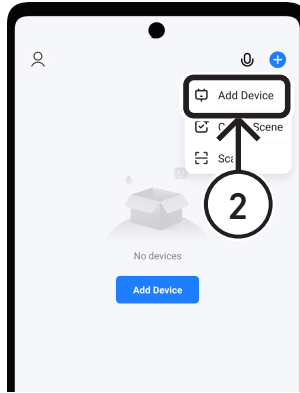
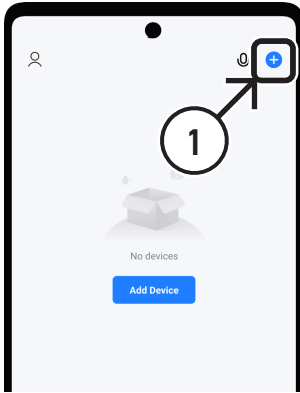

4. Then follow the prompts of your specific device to allow and enable Location and Bluetooth access.
5. Your specific device may prompt you to allow Smart Life to find nearby devices. Follow the prompts on your device to allow this function.

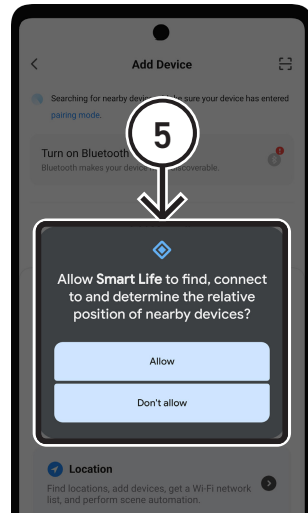

ADD A DEVICE ...CONTINUED

6. Ensure Bluetooth is enabled on your device.
7. Locate the Pairing Button on the bottom of the iRIS Controller.
8. Press and hold the pairing button for **at least 5 seconds**. After holding for **at least 5 seconds**, release the button, the Status Light next to the pairing button should now be **Flashing**.

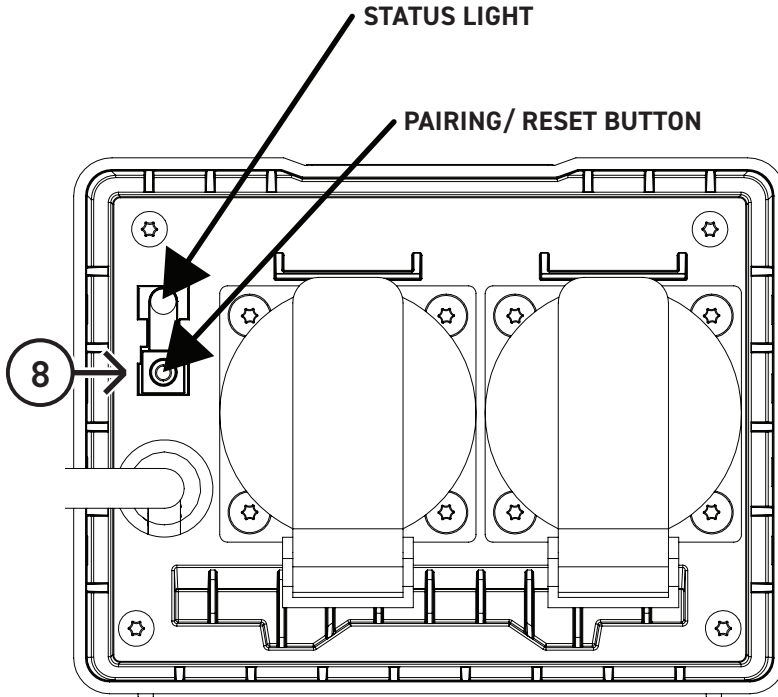

ADD A DEVICE ...CONTINUED

IMPORTANT



Ensure that the Status Light is flashing before proceeding to Step 9.

The device will **NOT** pair successfully otherwise.

If the status light is **NOT** flashing, repeat Step 8.

- Now that the status light on the iRIS Controller is flashing, wait for the Add button to appear with the text "Discovering Devices". Then Tap "Add".
If the "Discovering Devices" prompt does not come up. Check that Bluetooth is turned on. Alternatively you can manually add the iRIS controller by tapping the "Socket Wi-Fi" option indicated below (**see fig. 9a**) and following the on screen prompts.
- Enter the Network ID and Password of the Wi-Fi network you want your iRIS Controller to connect to. Note: if your smart device is connected to a Wi-Fi network, this Network ID may already be selected.
- Then Tap "Next".

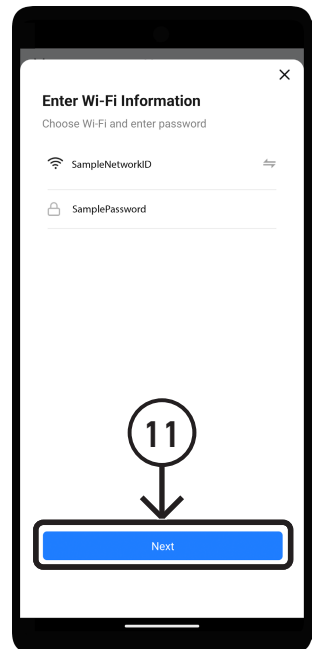
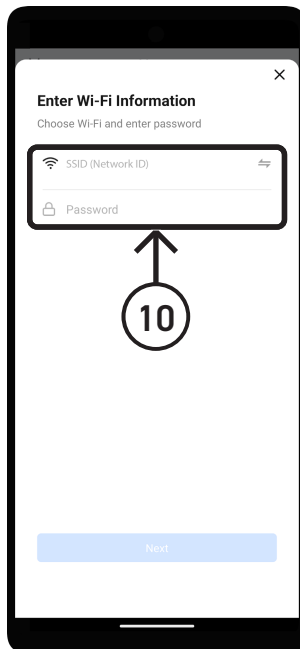
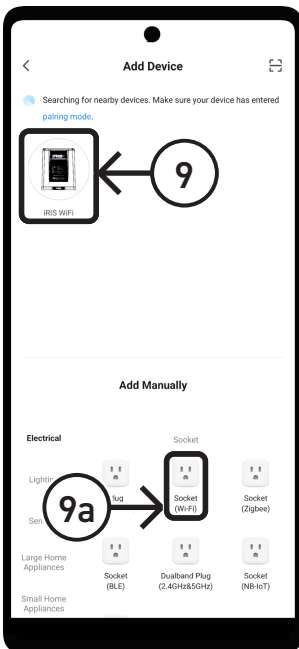

ADD A DEVICE ...CONTINUED

12. Wait for the iRIS Controller to be added.
13. Once the iRIS Controller has successfully been added, indicated by a green tick, Tap "Done".



Your iRIS Controller is now Successfully setup and ready for use.

Note: If the colours selected in the app do not match the colour of the lights, go to Multi Plus Setup section of this instruction manual and follow the steps to put the lights into iRIS Controller mode.

MULTI PLUS SETUP

BEFORE YOU START

The following setup instructions are only required if the lights are not changing to the correct colours based on the colours selected in the app.



iRIS is compatible with Spa Electrics MULTI PLUS lights only.

The MULTIPLUS light has 9 inbuilt modes of operation for use on a variety of different control systems or installation types.

When you first install your MULTIPLUS light it will operate in the default, 'Manual' mode for use with a wall switch. In order to connect the light to Spa Electrics iRIS Controller mode, please follow the below steps.

Disconnect any blowers, pumps or devices from the iRIS WiFi if they may be sensitive to short duration power cycling (4 seconds ON, 10 seconds Off). After completing the Multi Plus Setup, you may reconnect these other devices.

iRIS Wi-Fi LIGHTING CONTROLLER QUICK SETUP

1. Tap the Settings  button.
2. Tap "OK" to enter settings.
3. Tap the Support  button.

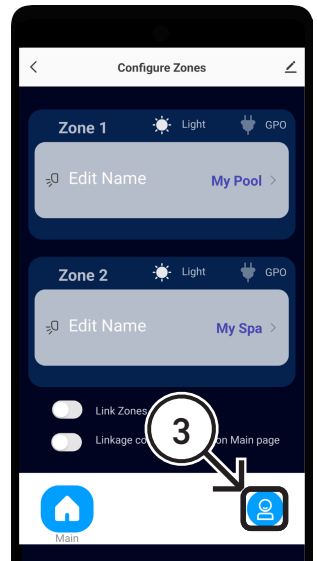
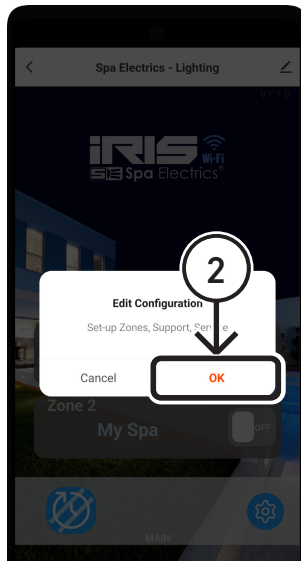
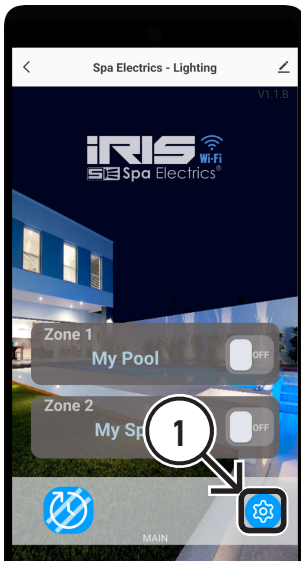

MULTI PLUS SETUP ...CONTINUED

4. Tap and Hold the Service  button.
5. Tap "OK" to enter Service Mode.
6. Double Tap "Set Mode".

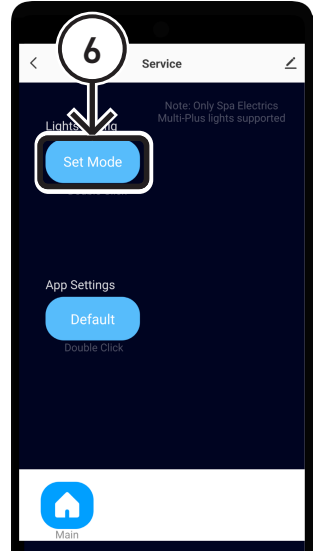
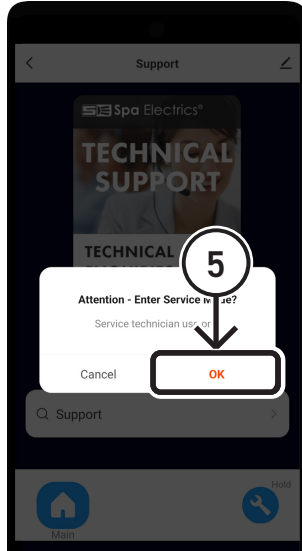
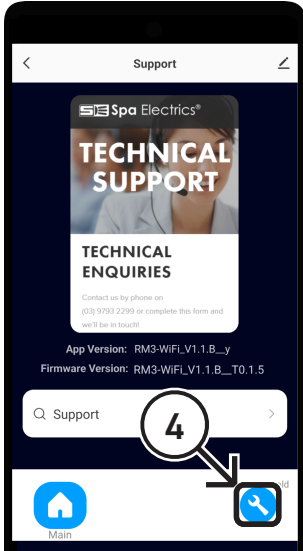

7. Tap "OK" to automatically setup the lights into iRIS mode.
8. Wait on this screen until the flashing "Please Wait!" message disappears permanently. This will take 2+ minutes.

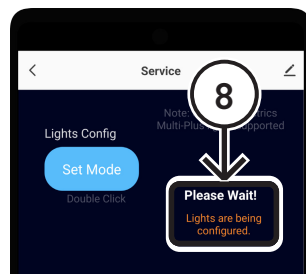
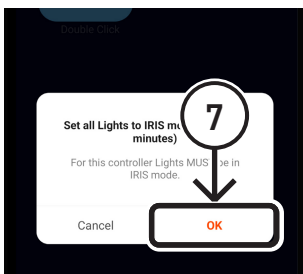

Your lights should now be in iRIS mode and ready for use.

Note: Confirm your lights operate correctly by selecting colours in the app and confirming the correct colours are output from the lights.

OPERATING INSTRUCTIONS

TURNING LIGHTS ON

1. Tap the iRIS WiFi from the Smart Life Apps list of devices.
2. Tap the On/Off toggle of either Zone 1 or Zone 2, to turn the lights of that zone on.

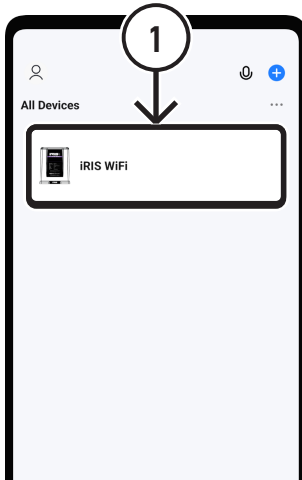

CHANGING SOLID COLOURS

1. Tap either Zone 1 or Zone 2, to turn the lights On and go to the colour change menu.
2. Tap one of the colour options on the screen to change the output colour of the lights connected to the zone.

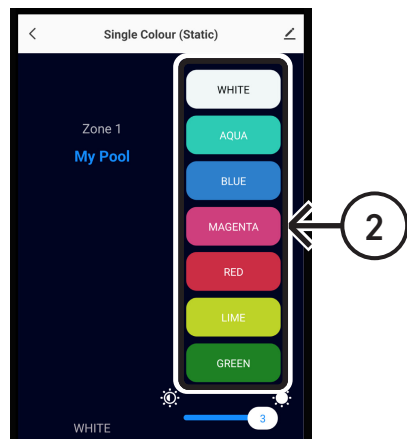

CHANGING SOLID COLOURS ...CONTINUED

- The brightness of the colour can be changed from 1 (dimpest) to 3 (brightest) by moving the slider.

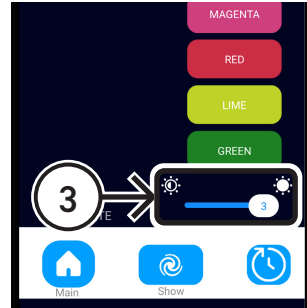

COLOUR SHOWS

- Tap the Show  button to go to the Colour Shows menu.
- Tap one of the four Colour Shows to change the output of the lights connected to the zone.
- The speed of the Colour Show can be changed from 1 (slowest) to 3 (fastest) by moving the slider.
- The brightness of the Colour show can be changed from 1 (dimpest) to 3 (brightest) by moving the slider.
- If your lights appear to be out of sync with each other, Tap the "Sync" button to resynchronise the lights.

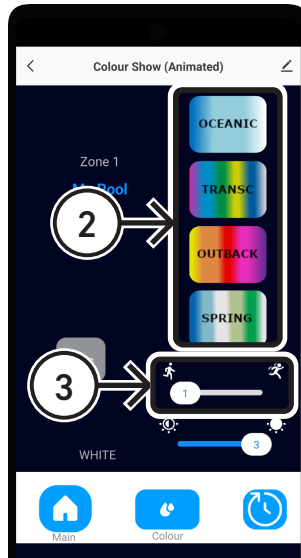
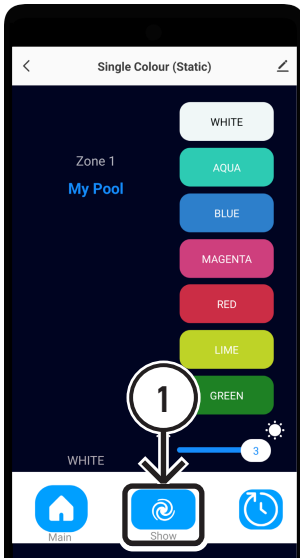

SCHEDULING

1. Tap the Schedules  button to go to the Schedules menu.
2. Tap the On/Off toggle to enable Schedules.
3. Tap either Zone 1 or Zone 2, to view the list of schedules and to Add/Edit/Remove schedules for that Zone.

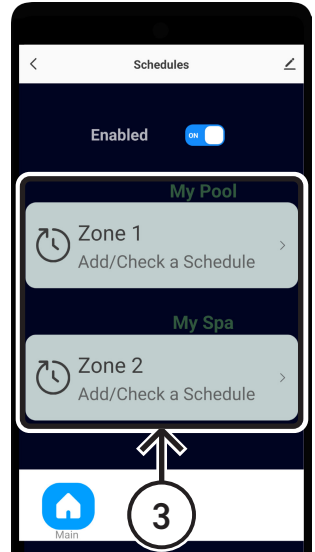
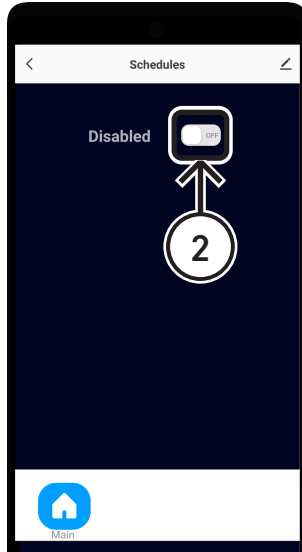

4. Tap the "Add" button to add a new schedule.

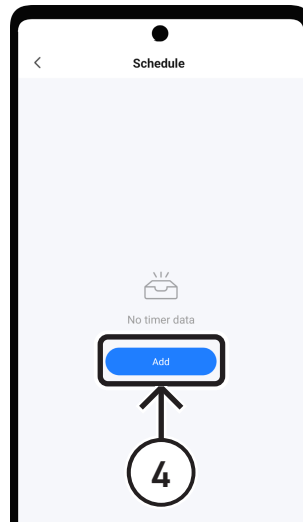

SCHEDULING ...CONTINUED

5. Set the start time for the schedule.
6. Set the days of the week the schedule will repeat.
7. Add a note for this schedule (optional).
8. Tap the On/Off toggle to receive a notification when the schedule is activated.
9. Set the duration in hours and minutes for the schedule. (This is the length of time the lights will be on from the start time before turning off).
10. Set the Colour/Show and the Brightness (1 dimmest to 3 brightest). Also if selecting a Show, the speed can be set (1 slowest to 3 fastest).
11. After entering all the details of the schedule, Tap "Save".
12. When viewing the list of schedules, you can Tap a schedule to edit them.
13. Tapping the On/Off toggle on a schedule will enable/disable it.

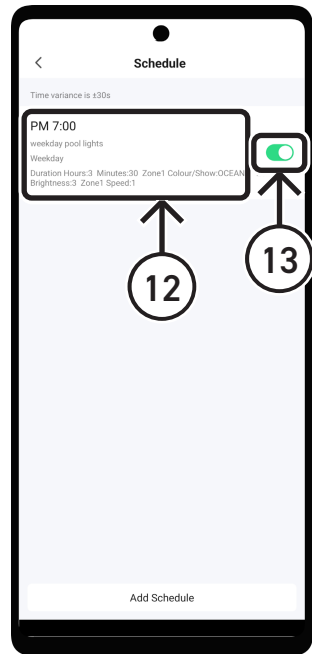
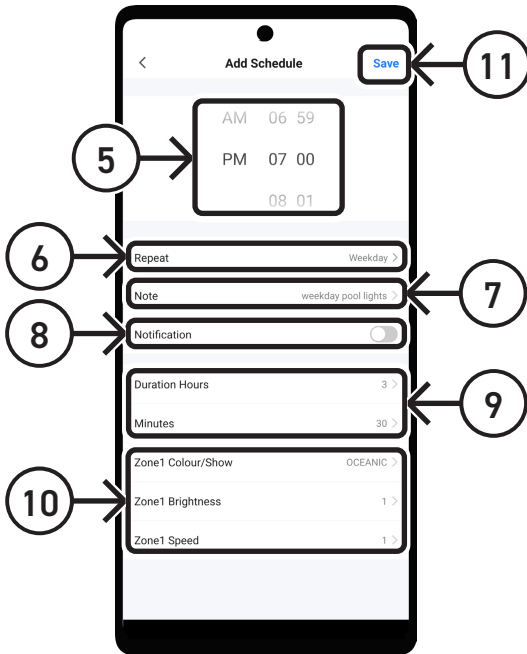

ZONES

The iRIS Wi-Fi Lighting Controller has two separate outputs which correspond to two separate Zones within the app.

These Zones can be operated independently and can, as an example, be used to operate swimming pool lights separately to spa lights. Some users may also use Zones to control lights with one Zone and on the other Zone power on swimming pool accessories (see Accessory Devices section and Appendix 2).

LINKING ZONES

Zones can be linked so that Solid Colours/ Colour Shows/ Schedules selected in Zone 1 are automatically duplicated in Zone 2.

1. Tap the Settings  button.
2. Tap "OK" to enter settings.
3. Tap the "Link Zones" toggle button to link Zone 1 and Zone 2.

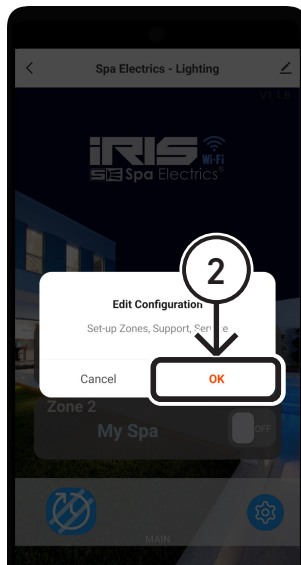
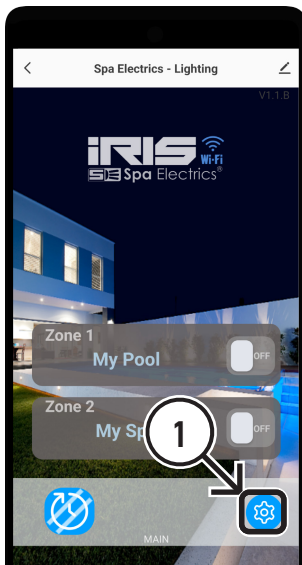

RENAMING ZONES

1. Tap on one of the Zone names.
2. Enter the new name of the Zone.
3. Tap "Confirm" to save the new name.

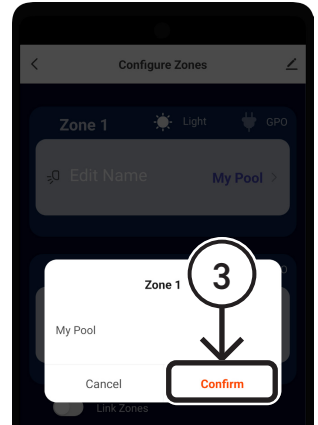
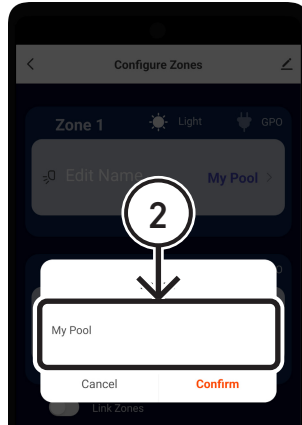
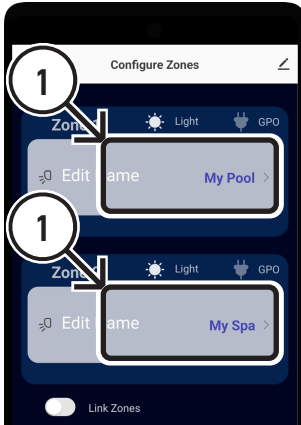

ACCESSORY DEVICES

The iRIS Wi-Fi Lighting Controller can be used to power accessory devices such as blowers, vacuums, filters, heaters, etc. For example you could connect your lights to Zone 1, and then connect your spa jet blower to Zone 2. See Connecting to Transformers section of this document for a diagram of Zone 1 and 2 locations on the bottom of the iRIS Wi-Fi Lighting Controller.

When connecting an accessory device to a Zone instead of light transformer, that Zone should be set to G.P.O. mode in the Zone Configuration screen of the app.

1. Tap "GPO" on the Zone you have an accessory device connected to.
2. Tap "OK" to confirm.

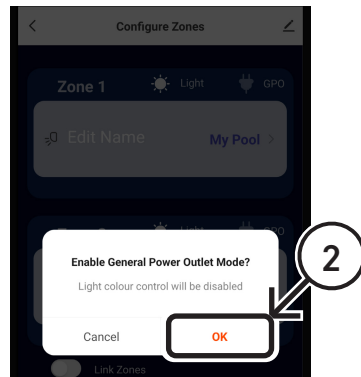

TECHNICAL SPECIFICATION

Input: 230-240VAC - 50Hz

Output: 2 X 240VAC - 50Hz switched

Max. Load: 2400W MAX. TOTAL

APPENDIX

1. Guest Mode Operation: All functions of the iRIS Wi-Fi Controller operate normally, including schedules. You can also receive notifications even in Guest Mode.
Limitations of Guest Mode: Access to the iRIS Controller cannot be shared to other Smart Life app users/ accounts. If the Smart Life app is re-installed or Guest Mode is exited, the iRIS Controller will need to be reconfigured and existing settings and schedules will be lost.
2. Accessory Devices: Examples of accessory devices you may want to install to the iRIS Controller: blowers, vacuums, filters, heaters, etc.
IMPORTANT NOTE: The total maximum current for the iRIS Controller is 10A. The combined load across both G.P.O. must not exceed 10A (including any light transformers that are connected).

TROUBLESHOOTING

CONDITION

CORRECTIVE ACTION

Colour selection not functioning correctly/ Wrong colours output

Go to Multi Plus Setup section of this document and follow the instructions

Different lights outputting different colours than each other or colour shows not in sync across all lights

Go to Colour Shows section of this document and follow step 5 to resynchronise the lights

PAGE INTENTIONALLY LEFT BLANK

PAGE INTENTIONALLY LEFT BLANK

NOTE



PLEASE STORE THIS MANUAL IN A SAFE
PLACE FOR FURTHER REFERENCE

 **Spa Electrics**[®]

© COPYRIGHT 2024 SPA ELECTRICS PTY. LTD.
ALL RIGHT RESERVED

2024 07 29